



MULTIPURPOSE ARENAS

Sports halls

Music venues

Trade fairs

Large scale events

Versatile solutions
for epic **events**

www.irmarfer.com

IRMARFER
STRUCTURES

WHY IRMARFER?



We have **25 years of experience** in supplying structures for a wide range of uses worldwide. The **recognition** of our products and services is a reality on a **global scale**. Our wide experience in **designing, manufacturing, and delivering** structures, allied with our **constant investment** in **developing** and **innovating new solutions**, places us as the **Iberian leader** in the industry, and one of the worldwide reference players in the structures market.



COST-EFFECTIVE

Less expensive than traditional buildings. They require less material and labor to manufacture, transport, and assemble, making them a cost-effective option for many applications. Possible to achieve **70% of cost savings** when compared to a permanent building.

FLEXIBILITY

We can design structures of **any size**, and install them in almost any location. We can sell or hire for the time that suits your needs. The structures can be **modified or relocated** to fit your business requirements.

QUICK INSTALLATION

Easy to transport, assemble, and reassemble, a temporary structure can be **installed in a few days**, reducing labor costs and minimizing disruptions to ongoing operations.

RISK MANAGEMENT

In uncertain times, a temporary building is a **lower risk option** than constructing a permanent facility.

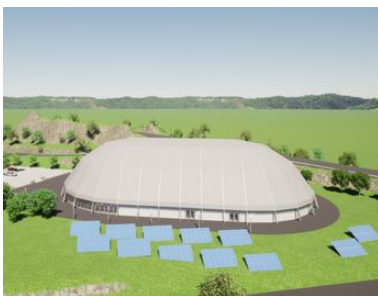
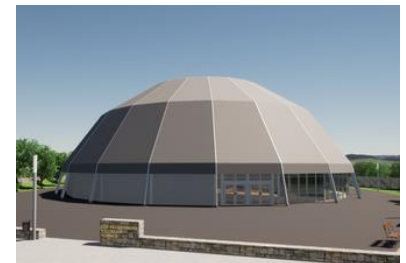

SAFETY

Independent of the purpose, our structures follow all the specific requirements regarding **stability** and **safety**. Our structures are made of fire, snow, and windproof materials and are in compliance with EN 13782 for temporary structures and any applicable code or standard for permanent structures.



DURABILITY

All of our structures are resistant to environmental influences and can have a **useful life of up to 60 years**. Such characteristics are possible due to the use of **high-quality materials** and state-of-the-art processing methods. They can withstand cyclones, storms, rain, and strong sunlight for long periods.

CE Our products are CE compliant



IRMARFER ALUMINIUM SYSTEM

Why choose aluminium?

1

ADAPTABLE & RELOCATABLE

Aluminium is a highly versatile material, so it can be fabricated into a wide range of shapes and sizes. It's also lightweight so it's easy to transport, assemble, disassemble and relocate the structures. The modular system allows to expand and adapt the structures to all needs.

2

LOW MAINTENANCE

Aluminium requires minimal maintenance, which makes it a cost-effective material. Unlike other metals, like steel, aluminium is naturally corrosion-resistant, so it does not need to be painted or coated to protect it from corrosion.



3

SHORT BUILDING TIME

All products are designed and produced for a simple and fast assembly process. The assembly of all elements is done by clicking and/or bolting methods, reducing the construction time.

4

RECYCLABLE & SUSTAINABLE

Aluminium is 100% recyclable, it can be recycled over and over again without losing its properties. Which makes it an environmentally friendly. It has an extended service life and less waste of resources. Low CO2 footprint.

5

TRANSPORT & LOGISTICS

Due to its low density, malleability and lightweight, aluminium is easy to transport. Doesn't require extensive protective measures, reducing transportation costs, and it also has a lower environmental impact.

ALUMINIUM CONSTRUCTION VS STEEL CONSTRUCTION

Density: The density of aluminium is about one-third that of steel

Maintenance of buildings:

- Aluminium can be 8 times cheaper to maintain than steel, in an aggressive environment
- Aluminium can be 5 times cheaper to maintain than steel, in a normal environment.

IRMARFER ALUMINIUM SYSTEM

Aluminium Options

NON-ANODIZED ALUMINIUM

- more susceptible to corrosion, scratches, and wear
- uneven appearance
- less expensive
- faster to delivery

ANODIZED ALUMINIUM

- more resistant to corrosion, scratches, and wear
- more consistent appearance
- more durable
- more expensive

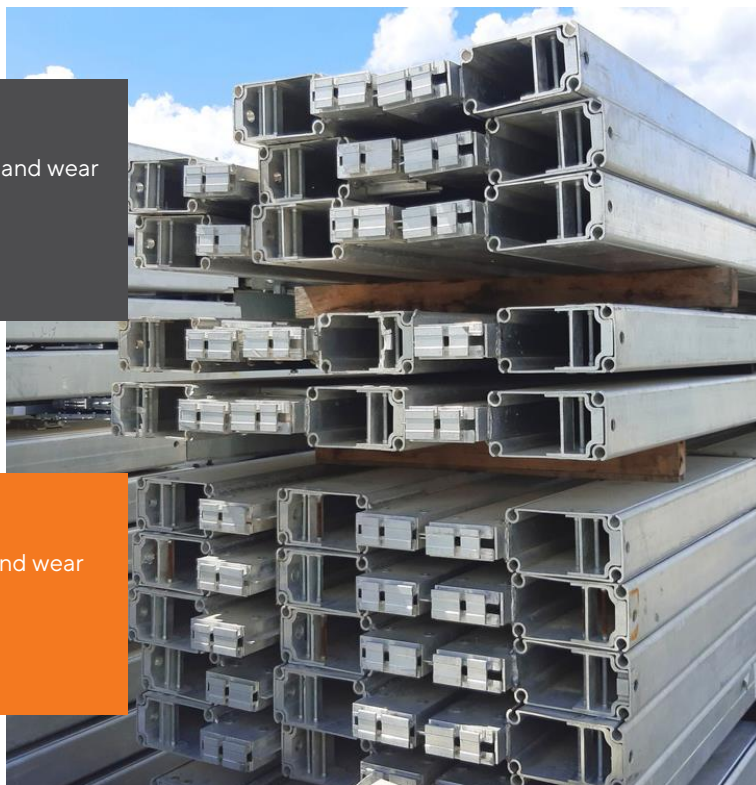

LACQUERED ALUMINIUM

Lacquered aluminium means that the aluminium has been coated with a layer of lacquer, a type of clear or colored varnish, that protects the aluminium and enhances its appearance. the lacquer coating provides a **smooth** and **glossy finish** that is **highly resistant** to corrosion, scratches, and wear.

Lacquered aluminium is commonly used in our padel and tennis structures.

E.g.: brown



E.g.: green



E.g.: black



MULTIPURPOSE ARENAS

HUGE RIGGING CAPACITY **LARGE-SPANS** **OUTSTANDING**
CUSTOMIZED **COST-EFFECTIVE** **MAXIMUM USABLE SPACE**
LONG-TERM **DURABLE** **SAFETY** **LIGHTWEIGHT STRUCTURES**

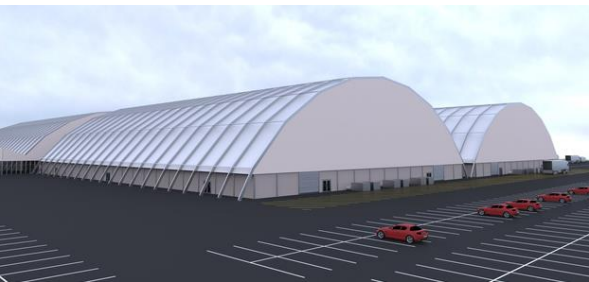
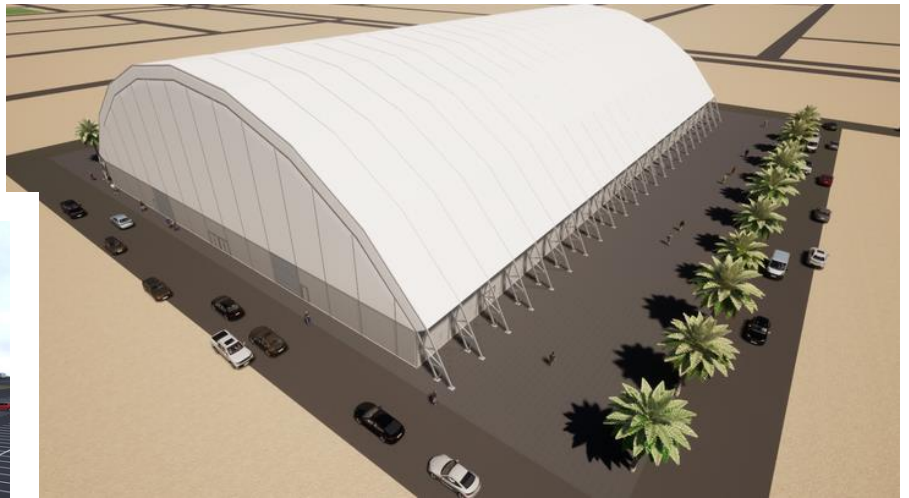
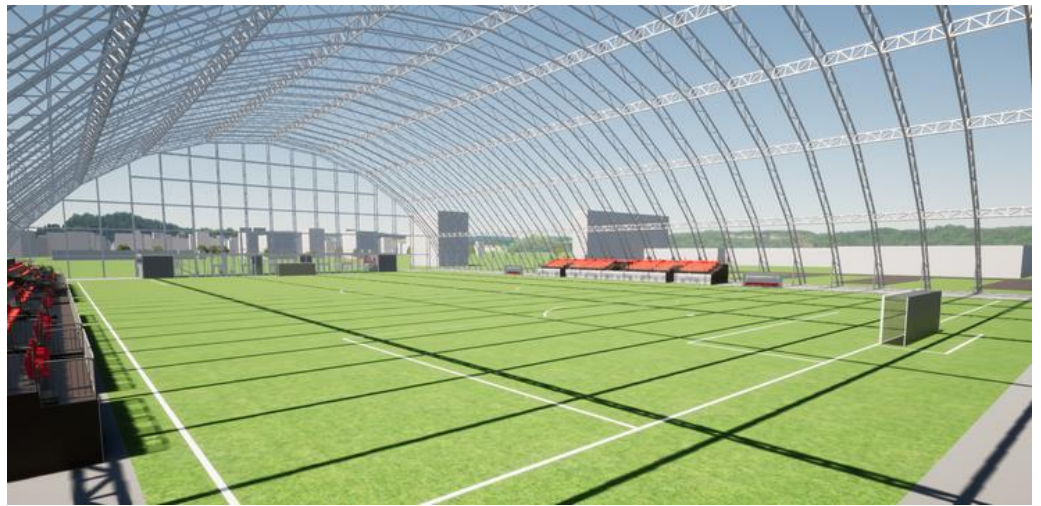

Irmarfer multipurpose arenas can be designed and customized to suit the specific requirements of **large-scale projects**. From sports halls to exhibition trade fair halls, we can design one-of-a-kind solutions that create the perfect atmosphere for your needs and **fully functional space**. Based on the **truss or mono-profile** construction, our solutions guarantee **versatility, durability, safety, and stability**. They are cost-effective long-term solutions that are quickly installed.

TRUSS OR MONO-PROFILE CONSTRUCTION

MULTIPURPOSE ARENAS

KEY ADVANTAGES:

- Maximum **usable space**
- Higher **stability** when subjected to loads
- 100% **removable** and **relocatable**
- **Fast** delivery and installation
- Structural **efficiency**
- Construction **simplicity**
- **Flexibility** in design

(designed to accommodate various loads, spans, and shapes, allowing for creative architectural designs and customization to meet specific project requirements)

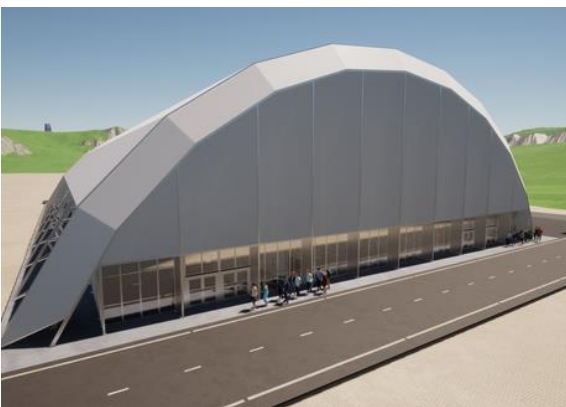
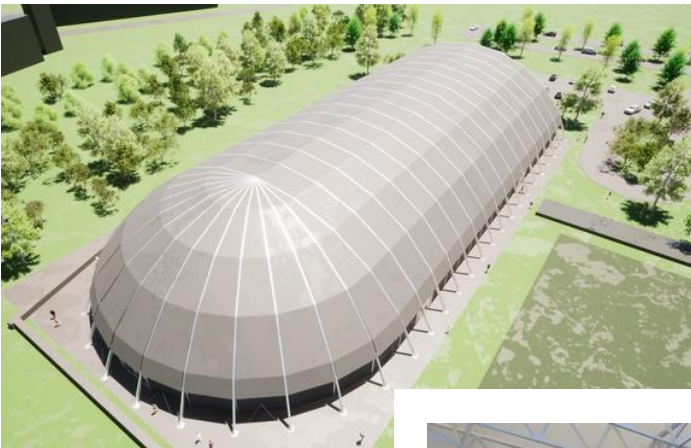

Extra accessories available: sectional gates, double doors, man doors, windows, LED lighting, HVAC, gutter, inner partitioning, access ramps, etc.

MULTIPURPOSE ARENAS

ARCH TRUSS CONSTRUCTION

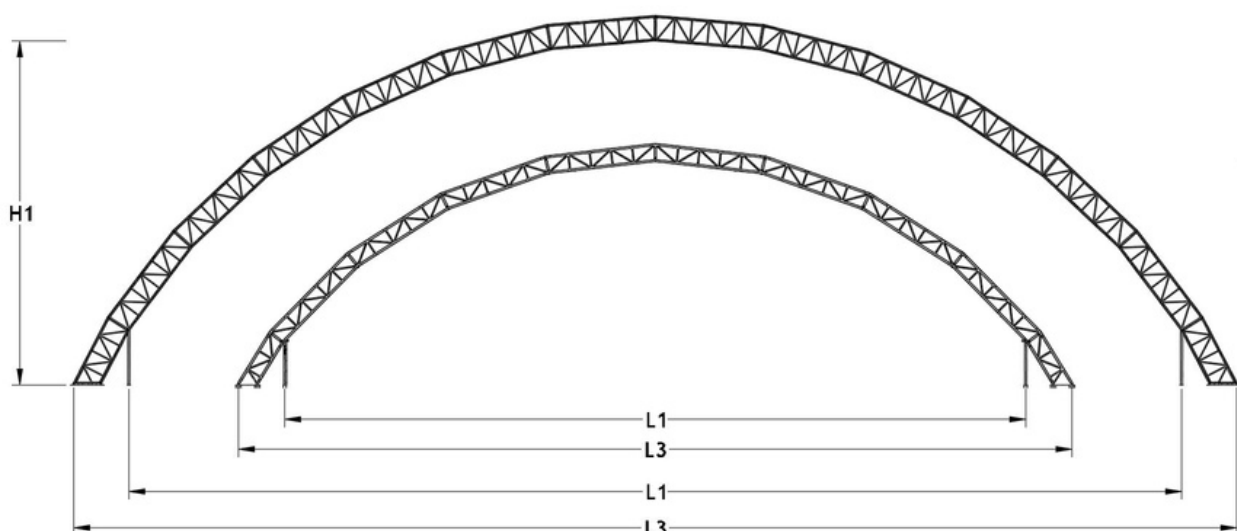
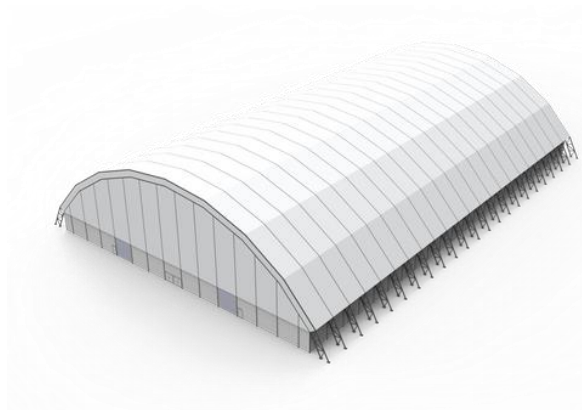
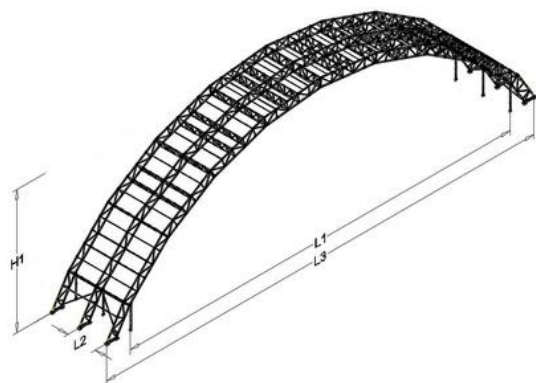

Specifications	Measure					
Inner Dimension	L1	60m	70m	80m	90m	100m
Outer Dimension	L3	68m	78m	90m	100m	110m
Ridge height	H1	18m	21m	27m	30m	33m
Bay distance / grid	L2	5m	5m	5m	5m	5m
Total Length		No limit. Expandable with the grid.				
Rigging Capacity - Up to	Per arch	7 tonnes	7 tonnes	12 tonnes	12 tonnes	12 tonnes
Max. wind speed - Up to		195km/h				
Snow load		0,1kN/m ²	0,1kN/m ²	0,1kN/m ²	0,1kN/m ²	0,1kN/m ²

Note: This is a summary of the main data and measurements of our standard structures. We can provide different options to match your requirements.

MULTIPURPOSE ARENAS

MONO-PROFILE CONSTRUCTION - IGLOO

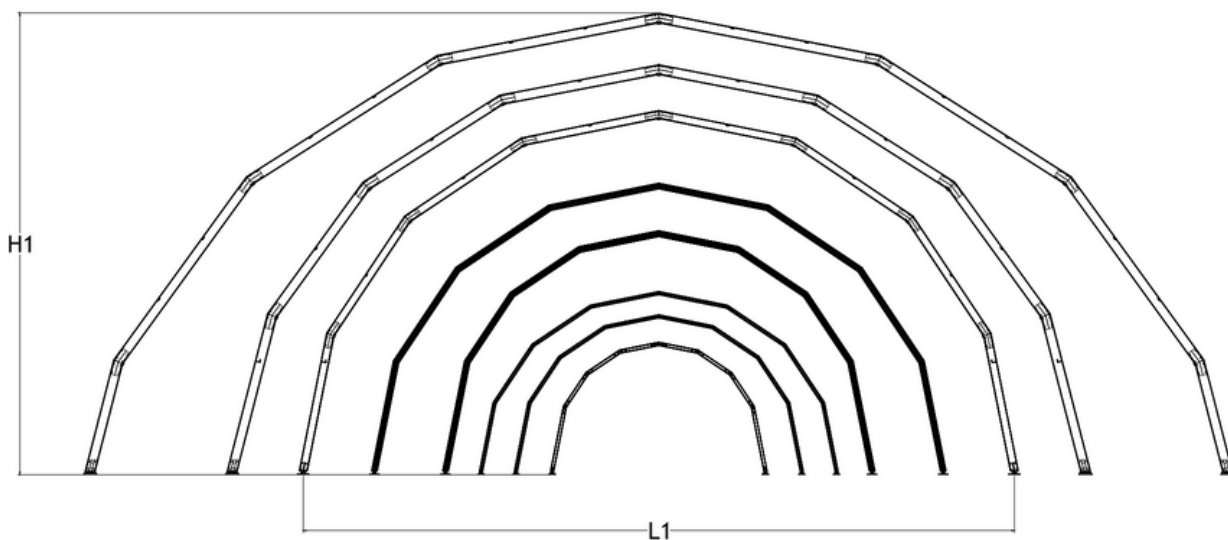
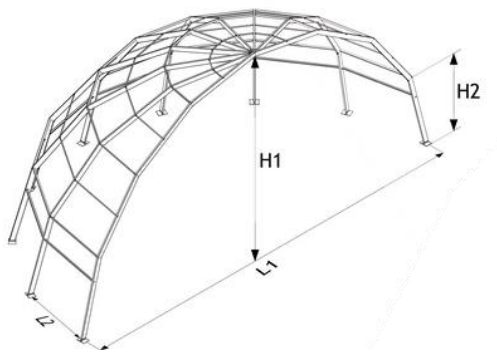

Specifications	Measure	7,5m	10m	12,5m	15m	20m	25m	30m	40m
Diameter	L1	7,5m	10m	12,5m	15m	20m	25m	30m	40m
Distance between feet	L2	3,75m	3,85m	4,78m	4,63m	5,17m	5,55m	5,65m	4,0m
External ridge height	H1	4,65m	5,62m	6,44m	8,56m	10,23m	12,78m	14,4m	6,25m
Feet height	H2	2,4m	2,5m	2,5m	4,0m	4,0m	5,0m	5,65m	4,0m
Bay distance / grid	L2	5m	5m	5m	5m	5m	5m	5m	5m
Total Length		No limit. Expandable with the grid.							
Rigging Capacity - Up to	Per arch	300kg	300kg	300kg	450kg	450kg	750kg	1250kg	1250kg
Max. wind speed - Up to		100km/h							
Snow load		0,1kN/m ²	0,1kN/m ²	0,1kN/m ²	0,1kN/m ²	0,1kN/m ²	0,1kN/m ²	0,1kN/m ²	0,1kN/m ²

Note: This is a summary of the main data and measurements of our standard structures. We can provide different options to match your requirements.

MULTIPURPOSE ARENAS

MONO-PROFILE CONSTRUCTION - WAVE

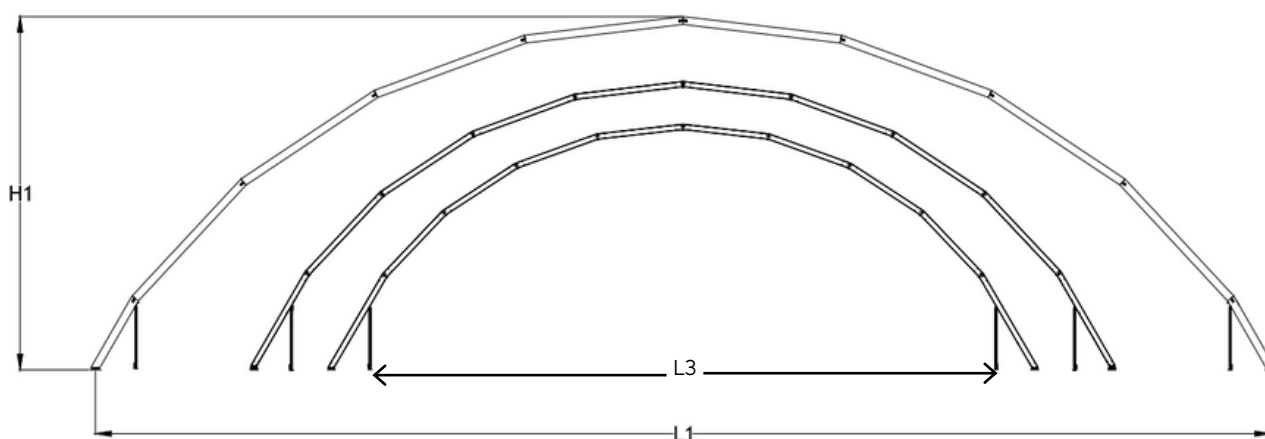
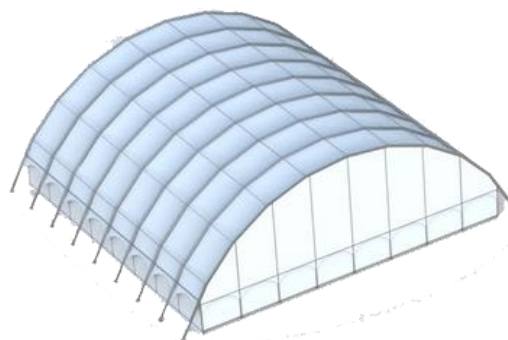
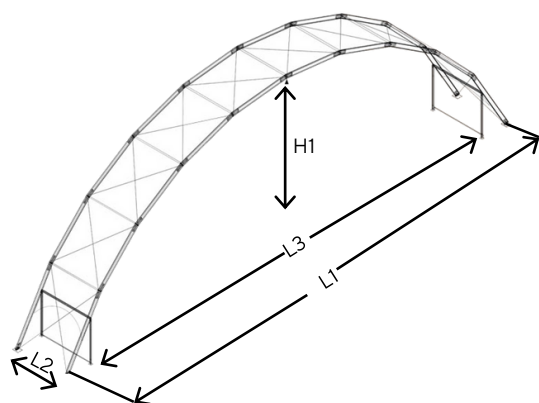

Specifications	Measure			
Outer dimension	L1	45m	55m	75m
Inner dimension	L3	40m	50m	70m
External ridge height	H1	15,6m	18,4m	22,5m
Feet height	H2	6,1m	6,3m	4,7m
Bay distance / grid	L2	5m	5m	5m
Total Length		No limit. Expandable with the grid.		
Rigging Capacity - Up to	Per arch	1500kg	2000kg	2000kg
Max. wind speed - Up to		100km/h		
Snow load		0,1kN/m ²	0,1kN/m ²	0,1kN/m ²

Note: This is a summary of the main data and measurements of our standard structures. We can provide different options to match your requirements.

MULTIPURPOSE ARENAS

TRUSS CONSTRUCTION

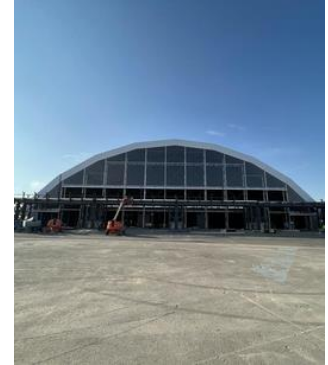

ONE-OF-A-KIND STRUCTURE

WIDTH Up to 100m

LENGTH Start at 5m to no limit

HEIGHT Up to 32m

UNBEATABLE STABILITY

MAXIMUM USABLE SPACE

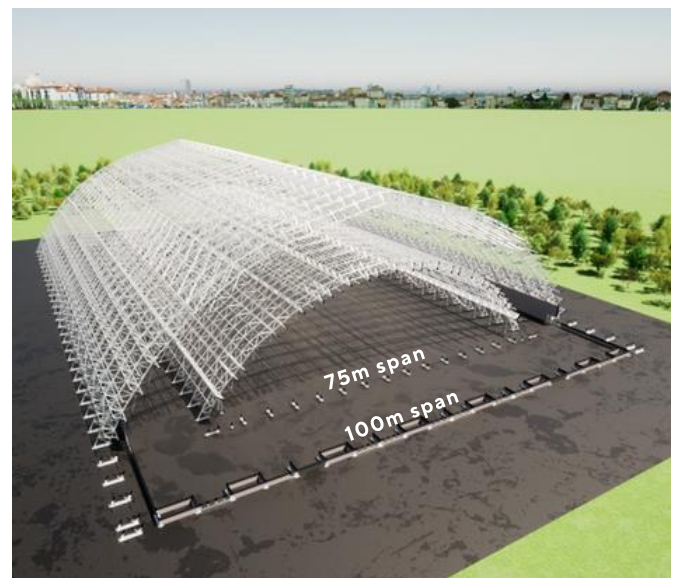

MULTIPURPOSE ARENAS

MONO-PROFILE CONSTRUCTION



LONG-TERM STRUCTURE

CUSTOMIZED SOLUTION

WIDTH	Up to 70m
LENGTH	Start at 5m to no limit
HEIGHT	Up to 23m

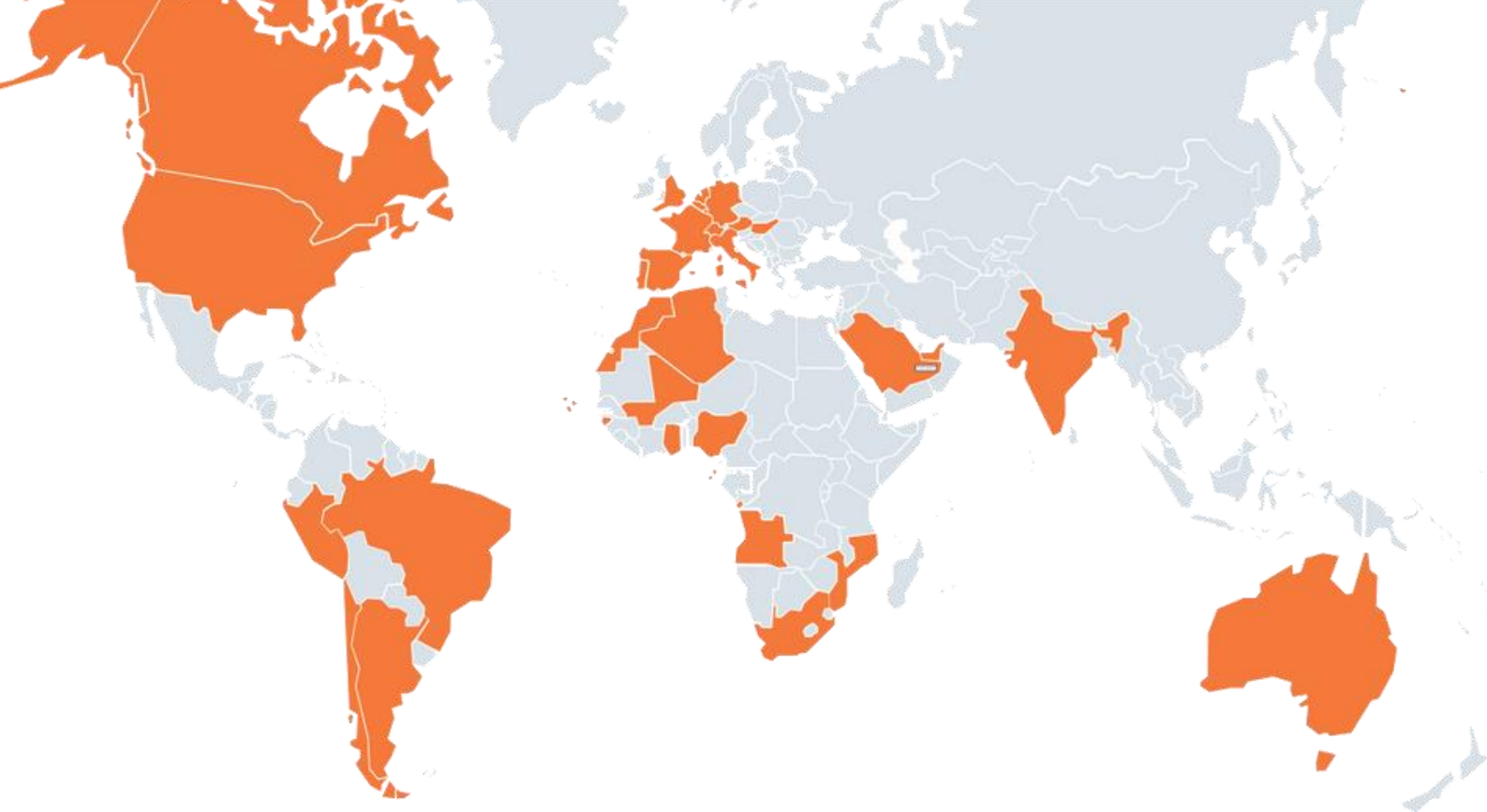

IRMARFER WORLDWIDE

Algeria	Cape Verde	India	Peru
Angola	Chile	Italy	Sao Tome and Principe
Argentina	England	Luxembourg	Saudi Arabia
Australia	France	Mali	South Africa
Austria	Germany	Morocco	Spain
Belgium	Ghana	Mozambique	Switzerland
Brazil	Guinea-Bissau	Netherlands	United Arab Emirates
Canada	Hungary	Nigeria	United States of America

CONTACTS

Rua do Pólo 6, 118
4590-373 Freamunde
Portugal

☎ (+351) 255 881786
☎ (+351) 910 696 202
✉ info@irmarfer.com

📘 /irmarfer
📷 /irmarfer.official
🌐 /irmarfer-structures

www.irmarfer.com

IRMARFER
STRUCTURES

IRMARFER
GRAPHIX

IRMARFER
INTERIORS